

DOI: 10.32663/ja.v%vi%i.2582

THE DESIGN MODEL OF INTENSIVE VANAME SHRIMP PONDS FOR ECO-GREEN AQUACULTURE DEVELOPMENT IN THE AREA OF PROBOLINGGO, EAST JAVA, INDONESIA

Jadfan Sidqi Fidari^{1*}, Maftuch, Andi Kurniawan, Mohammad Bisri

¹Coastal and Marine Research Center, Brawijaya University
Address: 1st Veteran street, Malang 65145, East Java, Indonesia

*Corresponding author, Email: jadfan@ub.ac.id

ABSTRACT

Probolinggo, East Java, Indonesia, is an area with a high potential for shrimp aquaculture because these areas meet the criteria for candidate vaname shrimp aquaculture. Probolinggo in tropical regions with stable climate dan sea waves that have the potential for vaname shrimp aquaculture. The analysis required the following data: tidal data, topographic maps, network layouts, and water quality data for shrimp. This research was conducted by using the facilities at the brackish water and Marine Fisheries Laboratory of Probolinggo; an eco-green aquaculture circulation system was modeled and assessed using shrimp pond. First, the survey was located in Probolinggo City area, with coordinates 7° 44' 30.03" S and 113° 13' 58.68". The methods used hydrological analysis: Water needs analysis for aquaculture irrigation based on the rules given by the Food and Agriculture Organization and water circulation analysis (Feedpedia, 2016). Material strength analysis of the embankments of the model pools: The comparison of area ratio toward embankment type dimension, design of dike and ponds, water filling discharge of brackish-water pond, and stages for ponds model design development. The results of the research suggested that dike should be planned to be as high as 1.5 m at the highest tide. The results of observations and tables of tidal recordings that had been verified then became the primary benchmark for planning the shrimp pond bottom. Based on the results of the analysis, it was found that the tidal height in the study location areas ranged from 2.5 to 3 m. A total of 80% of the area was used for production ponds.

Keywords: design model, eco-green aquaculture, Probolinggo

INTRODUCTION

Indonesia is one of the countries which have the longest Shoreline. Sen Nag (2017) mentioned Indonesia has shoreline 54,720 km long. Probolinggo is a city that as part of a coastal area in East Java with a significant potential for the development of fisheries, an industry with a high economic value. Claude (2003) gave indicators for potential locations for vaname shrimp aquaculture; sites in tropical regions with stable sea waves and climate have growth potential. Probolinggo is an area that meets

the criteria for potential vaname shrimp aquaculture; however, vaname shrimp have a high-risk level of cultivation. High-risk level of cultivation determine by Joffre (2018) is associated with a diverse range of risks and uncertainties, including volatile markets, climate variability, and production risks.

The high risks associated with shrimp farming are due to various causes. Mariane (2010) stated that the main cause was finding appropriate locations and modeling fish farm production in developing countries. Furthermore, the cultivation system and the

DOI: 10.32663/ja.v%vi%i.2582

open conditions of the pond location may also increase the risk of shrimp disease (Kautsk et al., 2000). Another problem is with increasing sea levels. Viv and Engki (2013) provided an estimate of the greenhouse effect causing a sea-level rise of 2–5 m and, on average, a sea-level rise of as high as 4–8 cm during the period 1985–2025. This sea-level rise also washes over the foreign material, especially during storm events, which can disrupt shrimp ponds.

Ling et al. (2013) listed some important requirements for vaname shrimp ponds. Pond design is important because it affects salinity and water circulation, which in turn greatly affects the growth and size of shrimp produced. This study attempts to model and assess shrimp pond water circulation and create an artificial ecosystem based on ecological systems for shrimp breeding with intensive methods and physical approaches.

MATERIAL AND METHODS

System Approaching

Recirculation Aquaculture System (RAS) became a commonly used solution to contribute food supply with the most productive utilization of limited land and water resources, as well as with the lowest possible load on the environment (Varga et al., 2020). To meet the requirement of RAS

we used tidal data from the progression of tidal compare with tidal data from Marine and Fisheries Ministry, the topographic map from Etopo 1 with resolution 0,25 degree, initial condition network layouts, and water quality data from field measurement with random sampling and continuous sampling. That the data mentioned above is for desk study analysis and model development.

Model Location

Initially, a survey was conducted to determine the location and initial plan for the pond model. Sites were located with coordinates 7° 44' 30.03" S and 113° 13' 58.68" E (Figures 1–3) within 100 m² area. The location that we choose for model location is behind the mangrove ecosystem area, industrial zone, and farming area. Semi-intensive and intensive farms although usually smaller in size have also contributed to mangrove loss and degradation both through habitat clearance and other environmental impacts such as the addition of artificial feeds, chemical inputs, and water requirements (Ashton, 2007). Hein (2000) mentioned in addition to the conversion of mangroves, shrimp aquaculture contributed to some other environmental and social conflicts. Base on that we propose a model that can be increased shrimp production but also have a minor impact on the ecosystem.



Figure1. The partition area situation of the existing pond

DOI: 10.32663/ja.v%vi%i.2582

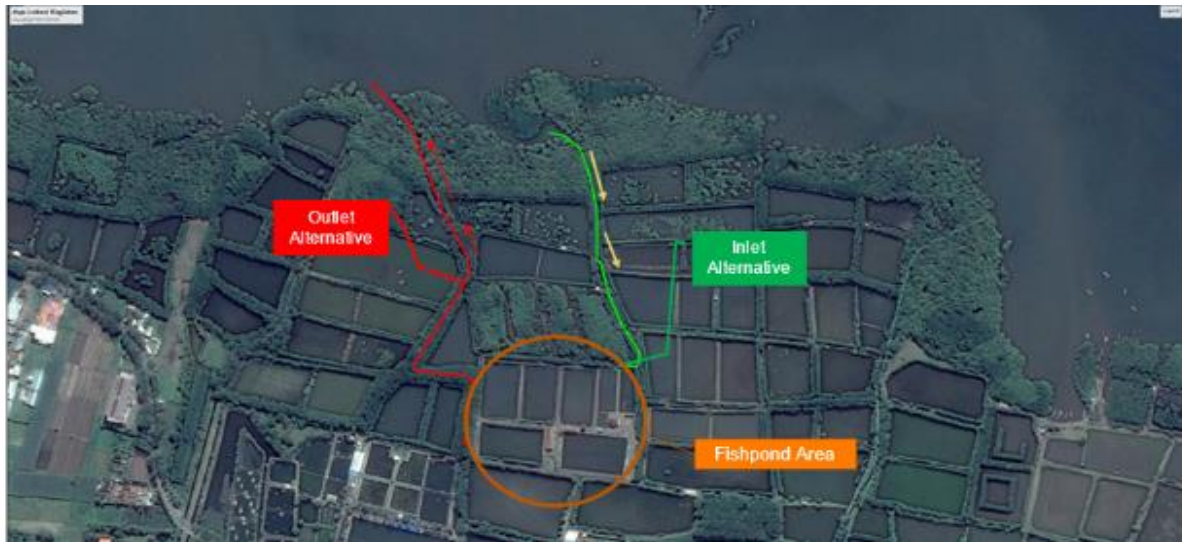

Figure 2. The substitute selection of inlet and outlet alternatives. (Source: Google Earth Image ©2017 CNES/Airbus)

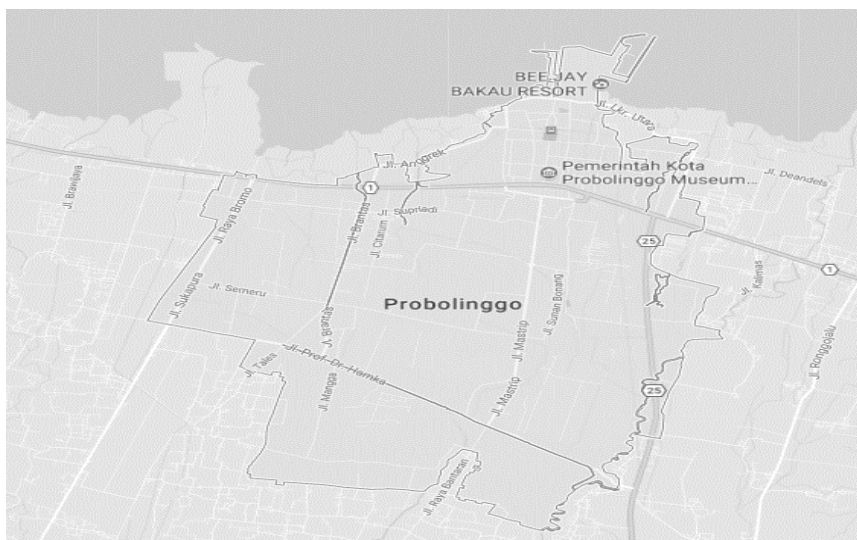

Figure 3. Map of administration and borders of Probolinggo City, showing the location of research plots

Water needs requirements

The number water requirements for aquaculture irrigation based on a Technical Manual For Small and Medium-scale Coastal Fish Farms In Southeast Asia given by the Food and Agriculture Organization (FAO) can be seen by the following equation:

$$Q = \frac{a \cdot h}{t \cdot \frac{(1 - \% \text{ loss})}{100}}$$

Where Q is discharge requirement (m^3/dt); t is the time required for filling the pond (s); h is the height for operation (m), and a is pond area (m^2). The gravitational system is applied in this model so the percentage loss of water input we used 70%. 30% is used to effect of losing water by sun radiation, climate condition, canal structure, and fluctuating wave.

DOI: 10.32663/ja.v%vi%i.2582

Water circulation process

The Major problem in the field is there is no separate channel for the inlet water system. The system has advantages for wave reduction because of the position behind the mangrove ecosystem but it has a lack of water quality also. The standard of water quality for shrimp follows regulation from the Indonesian Ministry of Marine and

Fisheries. As mentioned before, we designed the inlet, and outlet alternatives were chosen in the initial stage planning. The inlet line was used as the main source of water for the shrimp, whereas the outlet line was a part of drainage for draining water from the pond. Alternative details can be seen in Figures 2 and 4.



Figure 4. The substitute selection of inlet and outlet alternatives. (Source: Google Earth Image ©2017 CNES/Airbus)

Design of dike and ponds

Shunji et al. (2004) in Fisheries and Aquaculture of FAO provided the requirements for brackish-water pond design as shown in Figure 5. Inside the suggested requirements for shrimp farming, there should be at least four parts within the area of the pond: i.e., the hatchery pond, the feed distribution pond, circulation, and wastewater treatment plant. In this model, the water coming out of the ponds of aquaculture should meet river water quality standards at the estuary or the outlet. The concentration of dissolved organic substances downstream of the pond was

required to be as low as possible so that there would be no ecosystem condition changes outside the pond partition area.

The embankment design was divided into two sections: the part that was used as a perimeter (embankment separator) between the ponds and the part that was used as a pool border with the sea area following the division in Table 1. Shunji et al. (2004) provided the planning criteria for the extent of the pond partition area of vaname shrimp. The proportion of the area, which is the largest, was found in the production section pond (Tables 2 and 3).

DOI: 10.32663/ja.v%vi%i.2582

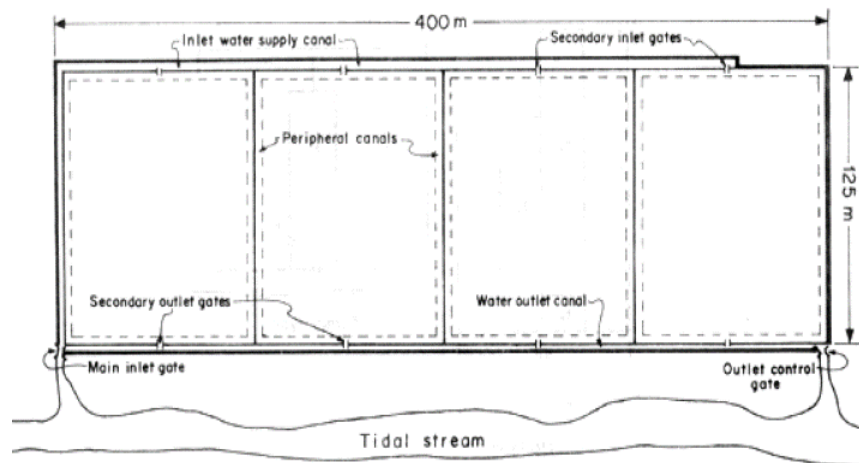

Figure 5. The partition pond design for mono-aquaculture (Shunji et al., 2004).

Table 1. The area criteria and proportion of brackish-water pond divisions.

Area	Note	Pond area criterion
1	Acclimatization pond	4–8 m ²
2	Hatchery pond	1% area
3	Transition pond	10% of the total area
4	Production pond	80% of the total area
5	Permanent pond (with door)	1.5% of the total area
6	Food growth pond	7% of the total area

(Source: Shunji et al., 2004)

Table 2. Design criteria of brackish-water embankment ponds.

Construction height of dike (m)	Side slopes 1.5L:1			Side slopes 2:1		
	Top width			Top width		
	1 m	2 m	3 m	1 m	2 m	3 m
0.5	0.8	1.3	1.8	1.0	1.5	2.0
1.0	2.5	3.5	4.5	3.0	4.0	5.0
1.5	5.0	6.5	8.0	6.0	7.5	9.0
2.0	8.0	10.0	12.0	10.0	12.0	14.0
2.5	12.0	14.5	17.0	15.0	17.5	20.0
3.0	16.5	19.5	22.5	21.0	24.0	27.0

(Source: Cruz, 2014)

DOI: 10.32663/ja.v%vi%i.2582

Table 3. Design criteria of shrimp pond embankment.

Note	Pond area criterion	Design area (m ²)	Pond's code
Acclimatization pond	4–8 m ²	8.000	
Hatchery pond	1% of the total area	52.853	B
Transition pond	10% of the total area	528.529	C
Production pond	80% of the total area	4246.658	D
Permanent pond (with door)	1.5% of the total area	79.279	A
Food growth pond	7% m ²	369.970	
	Total	5285.29	

The comparison of area ratio toward the embankment type dimension

The comparison for the area with the water level in the pond followed the requirements of brackish-water ponds of 0.02–0.06 ha area should have a water level depth of 1–1.5 m (Odge et al., 2005).

Based on the comparison ratio, the distribution and composition of the soil pile were factors that were considered for pond embankment and perimeter. The distribution and composition of the brackish-water embankment pond are following Low Su Ji, et al, (2017) and the layering of the material embankment are can be seen in Figure 6.

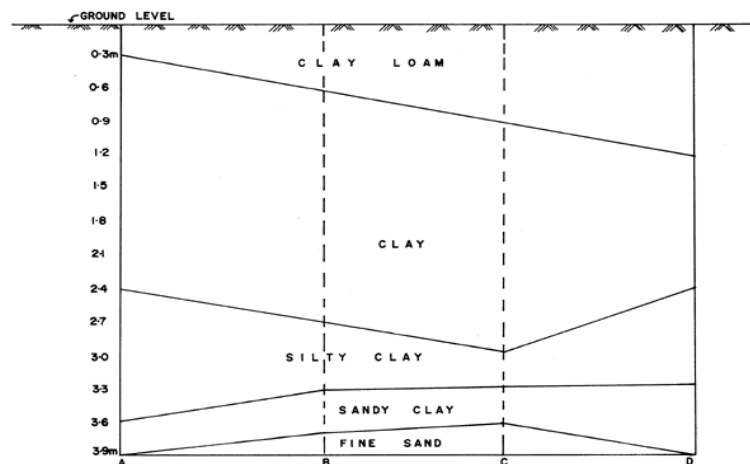

Figure 6. The distribution of soil characteristics to be used as embankment material and pond perimeter (FAO, 2016)

Water filling discharge of brackish-water pond

The discharge calculation for irrigation of the vaname shrimp pond was using the most common form flow rate equation by using the gate. The pressure is zero at the gate opening and the following equation is obtained for discharge:

$$Q = A_0 \sqrt{2gH_1}$$

Where:

Q = the discharge that went through the overflow (m³/s);

A₀ = Area of flow (m);

g = gravity acceleration (m²/s);

H₁ = head un the upstream of the gate (m).

DOI: 10.32663/ja.v%vi%i.2582

RESULTS AND DISCUSSION

Based on observation, the tidal height in the location areas ranged from 2.5 to 3 m. Tidal condition is classified as diurnal type so it will be changed every 12 hours. The observation result of water elevation change every hour can be seen in Figure 7, and the trend for 4 months can be seen in Figure 8.

Figure 8 shows tidal elevation changing start from January to April 2018, during observation data for 4 months, January has the highest tidal elevation rate in the early of the month and the lowest elevation in early April. A monthly comparison of the tidal fluctuating can be seen in Figure 10.

T J	1	2	3	4	5	6	7	8	9	10	11	12	13	14	15	16	17	18	19	20	21	22	23	24	J A T
1	1,50	0,95	0,52	0,28	0,26	0,46	0,84	1,30	1,72	1,99	2,05	1,94	1,71	1,48	1,31	1,28	1,41	1,70	2,10	2,54	2,87	3,00	2,86	2,46	1
2	1,89	1,26	0,69	0,28	0,09	0,16	0,46	0,92	1,43	1,85	2,08	2,11	1,95	1,71	1,47	1,33	1,33	1,51	1,84	2,27	2,69	2,97	3,01	2,77	2
3	2,29	1,66	1,02	0,47	0,11	0,01	0,16	0,54	1,05	1,57	1,96	2,15	2,12	1,94	1,69	1,47	1,36	1,40	1,62	1,98	2,40	2,78	2,98	2,92	3
4	2,60	2,07	1,44	0,82	0,33	0,05	0,02	0,26	0,69	1,21	1,70	2,04	2,18	2,12	1,92	1,68	1,49	1,41	1,49	1,73	2,08	2,47	2,77	2,88	4
5	2,75	2,38	1,85	1,24	0,68	0,27	0,08	0,13	0,42	0,87	1,37	1,80	2,09	2,18	2,10	1,91	1,69	1,53	1,48	1,57	1,80	2,12	2,44	2,66	5
6	2,70	2,52	2,15	1,65	1,11	0,64	0,32	0,20	0,31	0,62	1,05	1,50	1,88	2,10	2,17	2,09	1,91	1,72	1,58	1,54	1,63	1,83	2,09	2,33	6
7	2,47	2,46	2,27	1,93	1,50	1,05	0,68	0,44	0,39	0,53	0,83	1,22	1,60	1,92	2,12	2,17	2,10	1,94	1,77	1,64	1,59	1,64	1,78	1,96	7
8	2,12	2,22	2,19	2,04	1,77	1,43	1,08	0,79	0,63	0,61	0,76	1,02	1,35	1,68	1,96	2,14	2,19	2,13	1,99	1,82	1,67	1,58	1,58	1,64	8
9	1,75	1,87	1,94	1,95	1,86	1,68	1,43	1,17	0,96	0,84	0,84	0,96	1,18	1,46	1,75	2,01	2,19	2,24	2,19	2,03	1,84	1,65	1,51	1,44	9
10	1,44	1,50	1,59	1,69	1,75	1,75	1,66	1,50	1,31	1,14	1,05	1,04	1,13	1,31	1,56	1,84	2,09	2,27	2,32	2,24	2,05	1,82	1,57	1,37	10
11	1,24	1,19	1,23	1,35	1,50	1,64	1,72	1,70	1,60	1,46	1,32	1,23	1,20	1,27	1,43	1,67	1,95	2,21	2,37	2,39	2,27	2,03	1,73	1,42	11
12	1,16	0,99	0,93	0,99	1,16	1,39	1,61	1,75	1,78	1,71	1,59	1,46	1,36	1,33	1,39	1,56	1,81	2,10	2,34	2,47	2,44	2,25	1,93	1,57	12
13	1,21	0,92	0,74	0,70	0,83	1,08	1,38	1,65	1,81	1,86	1,80	1,68	1,55	1,45	1,43	1,51	1,70	1,98	2,27	2,49	2,55	2,44	2,16	1,77	13
14	1,35	0,96	0,67	0,52	0,55	0,76	1,08	1,44	1,73	1,89	1,92	1,85	1,72	1,60	1,52	1,52	1,65	1,88	2,17	2,45	2,60	2,58	2,36	1,99	14
15	1,54	1,09	0,71	0,46	0,38	0,50	0,80	1,18	1,55	1,82	1,95	1,94	1,84	1,72	1,61	1,57	1,63	1,80	2,08	2,37	2,60	2,66	2,53	2,21	15
16	1,76	1,28	0,83	0,49	0,32	0,34	0,56	0,93	1,33	1,68	1,90	1,96	1,91	1,80	1,68	1,61	1,62	1,75	1,98	2,28	2,55	2,69	2,65	2,40	16
17	1,99	1,49	1,01	0,60	0,35	0,28	0,41	0,72	1,12	1,51	1,80	1,94	1,93	1,84	1,72	1,63	1,61	1,70	1,89	2,17	2,45	2,66	2,71	2,55	17
18	2,20	1,72	1,22	0,77	0,45	0,30	0,35	0,58	0,94	1,34	1,68	1,88	1,93	1,87	1,75	1,64	1,59	1,63	1,78	2,03	2,32	2,57	2,69	2,63	18
19	2,36	1,94	1,45	0,98	0,60	0,38	0,35	0,51	0,82	1,20	1,56	1,81	1,92	1,90	1,79	1,65	1,57	1,56	1,67	1,87	2,15	2,42	2,60	2,63	19
20	2,47	2,13	1,68	1,21	0,80	0,52	0,42	0,50	0,74	1,09	1,45	1,74	1,91	1,93	1,85	1,71	1,58	1,52	1,56	1,71	1,94	2,21	2,43	2,54	20
21	2,48	2,25	1,88	1,45	1,04	0,72	0,54	0,55	0,71	1,00	1,35	1,66	1,88	1,96	1,93	1,80	1,65	1,54	1,50	1,57	1,73	1,96	2,19	2,35	21
22	2,39	2,27	2,02	1,66	1,28	0,95	0,72	0,65	0,73	0,95	1,25	1,57	1,82	1,97	2,00	1,93	1,79	1,63	1,52	1,49	1,56	1,71	1,90	2,07	22
23	2,18	2,17	2,04	1,81	1,51	1,20	0,95	0,81	0,81	0,94	1,18	1,47	1,74	1,94	2,05	2,05	1,96	1,81	1,65	1,53	1,48	1,52	1,62	1,76	23
24	1,88	1,94	1,93	1,83	1,66	1,43	1,21	1,03	0,95	0,99	1,14	1,37	1,62	1,86	2,03	2,13	2,13	2,03	1,87	1,69	1,53	1,43	1,41	1,45	24
25	1,54	1,62	1,69	1,72	1,69	1,59	1,45	1,29	1,17	1,12	1,16	1,30	1,50	1,72	1,94	2,12	2,23	2,24	2,14	1,95	1,72	1,49	1,33	1,23	25
26	1,22	1,26	1,35	1,46	1,56	1,63	1,62	1,54	1,42	1,31	1,26	1,29	1,40	1,57	1,79	2,02	2,23	2,37	2,38	2,26	2,02	1,71	1,41	1,16	26
27	1,00	0,94	0,98	1,11	1,30	1,50	1,66	1,72	1,67	1,56	1,44	1,36	1,35	1,44	1,60	1,84	2,12	2,37	2,53	2,54	2,37	2,05	1,66	1,26	27
28	0,93	0,72	0,65	0,73	0,94	1,24	1,54	1,77	1,86	1,82	1,68	1,52	1,40	1,37	1,44	1,62	1,91	2,24	2,54	2,71	2,68	2,44	2,02	1,53	28
29	1,05	0,67	0,44	0,40	0,55	0,87	1,28	1,66	1,92	2,01	1,93	1,75	1,54	1,39	1,34	1,43	1,66	2,00	2,39	2,71	2,86	2,76	2,43	1,92	29
30	1,35	0,82	0,41	0,21	0,24	0,49	0,92	1,40	1,82	2,08	2,13	1,99	1,76	1,51	1,34	1,30	1,43	1,72	2,13	2,55	2,86	2,95	2,77	2,34	30
31	1,75	1,13	0,58	0,20	0,06	0,18	0,54	1,06	1,59	2,00	2,21	2,19	1,99	1,71	1,45	1,28	1,27	1,46	1,81	2,26	2,68	2,95	2,96	2,68	31

Figure 7. Water Elevation During Tidal Event in Jan 2018 (Source: KSOP Class IV Probolinggo., 2018).

DOI: 10.32663/ja.v%vi%i.2582

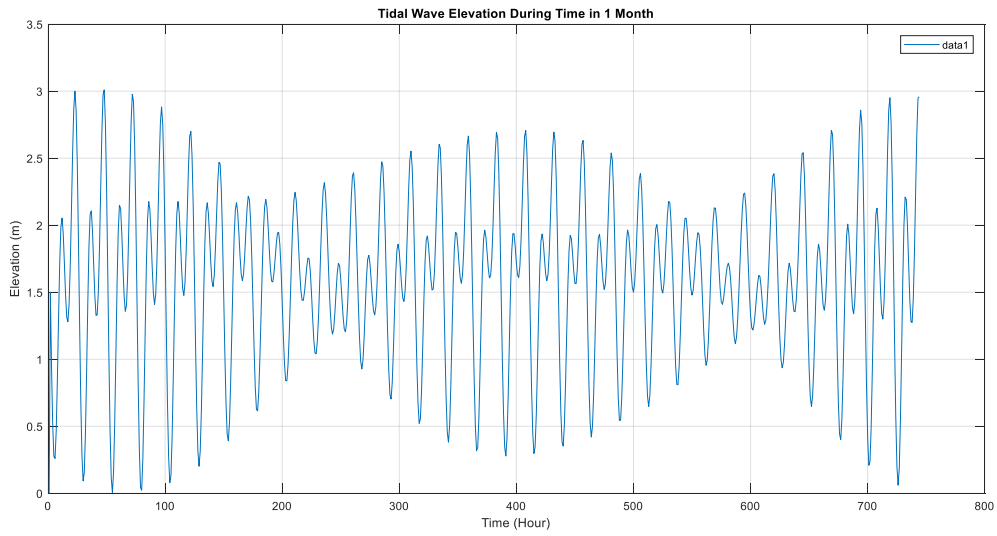

Figure 8. Tidal Event Fluctuation in 1 Month (Source: KSOP Class IV Probolinggo., 2018).

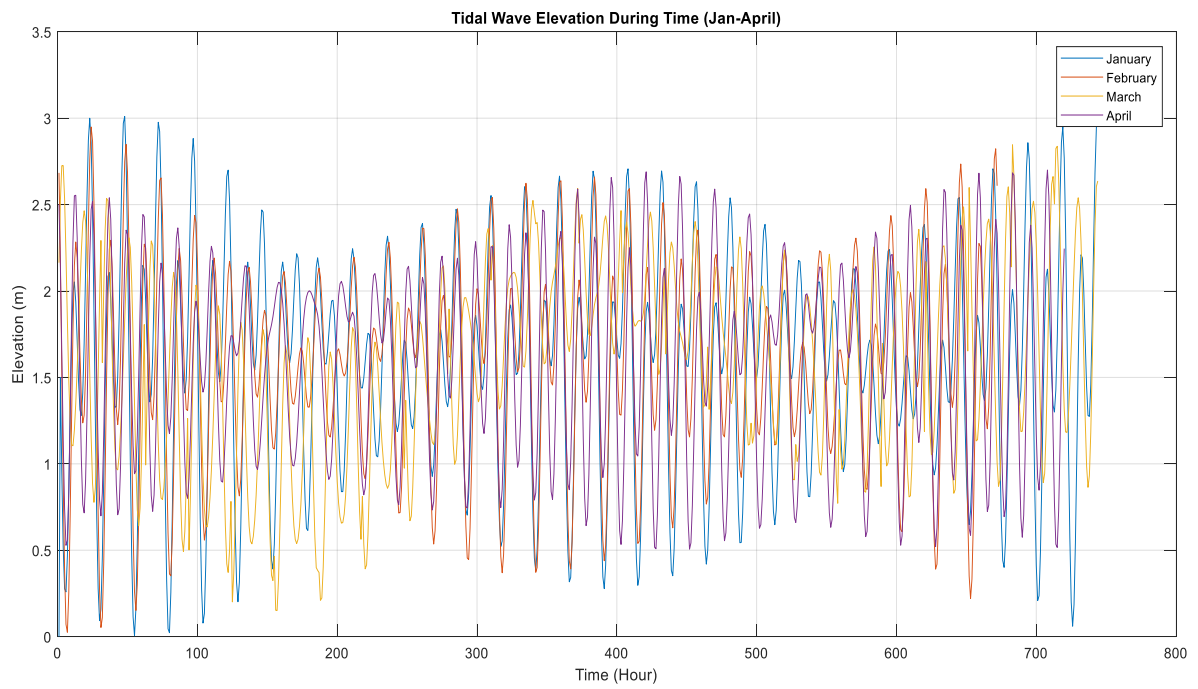

Figure 9. Tidal Observation during 4 Months (January – April 2018)

DOI: 10.32663/ja.v%vi%i.2582

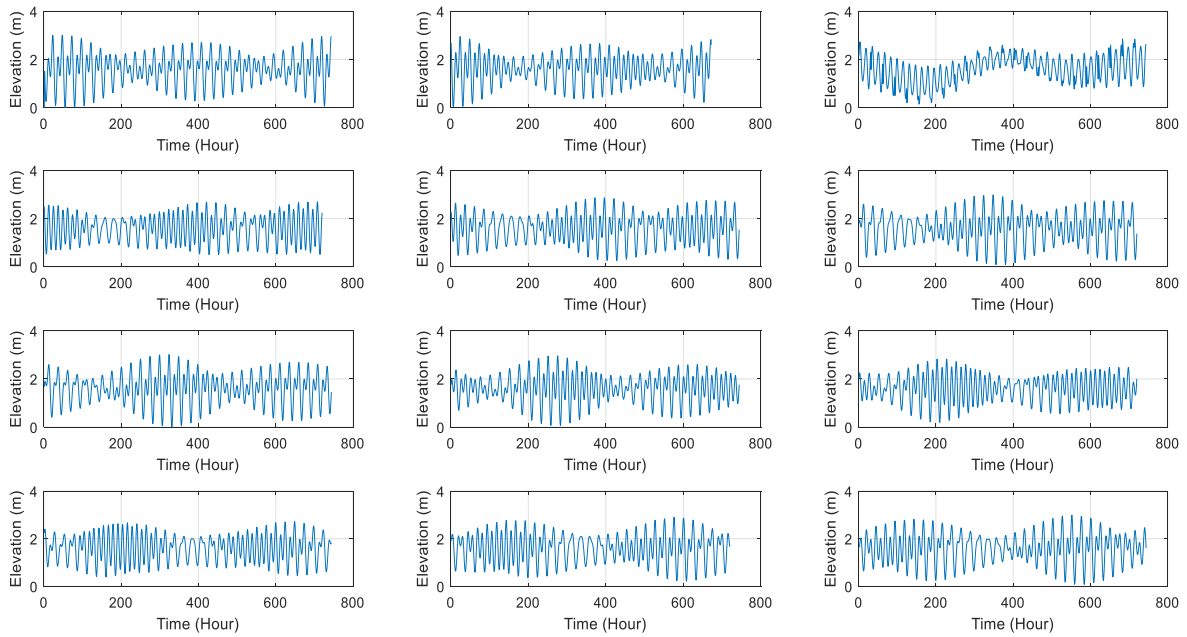

Figure 10. Monthly Tidal Fluctuation in 2019

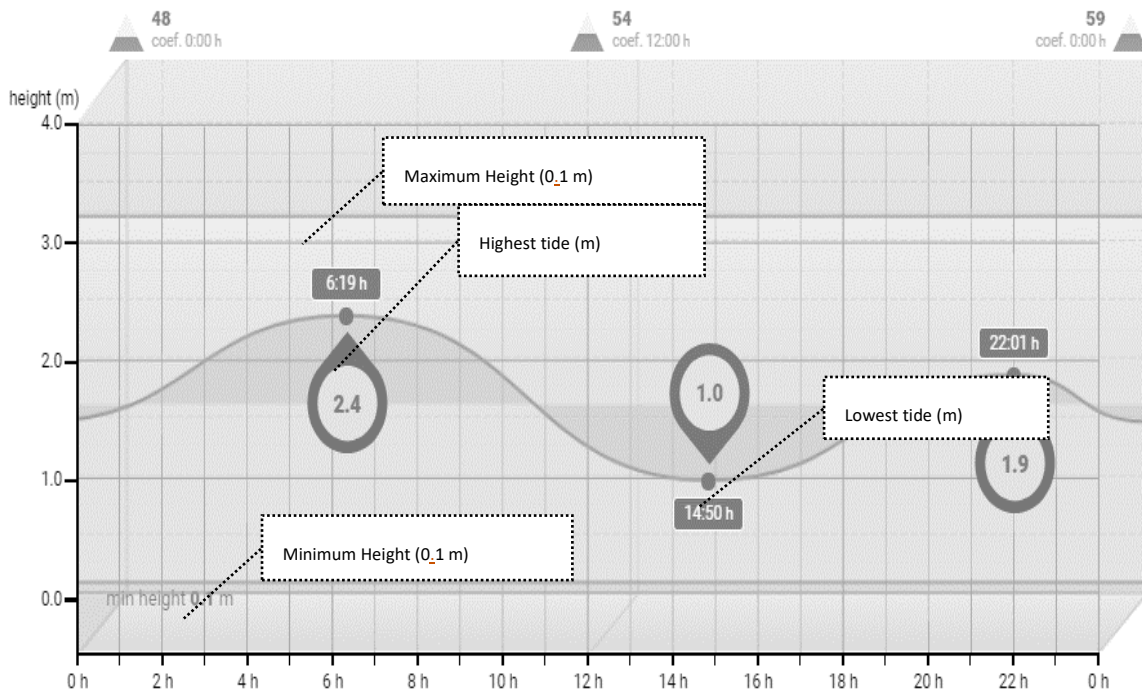

Figure 11. The fluctuation graph of tidal for shrimp pond in 2018. (Source: Tides 4 fishing, 2018).

DOI: 10.32663/ja.v%vi%i.2582

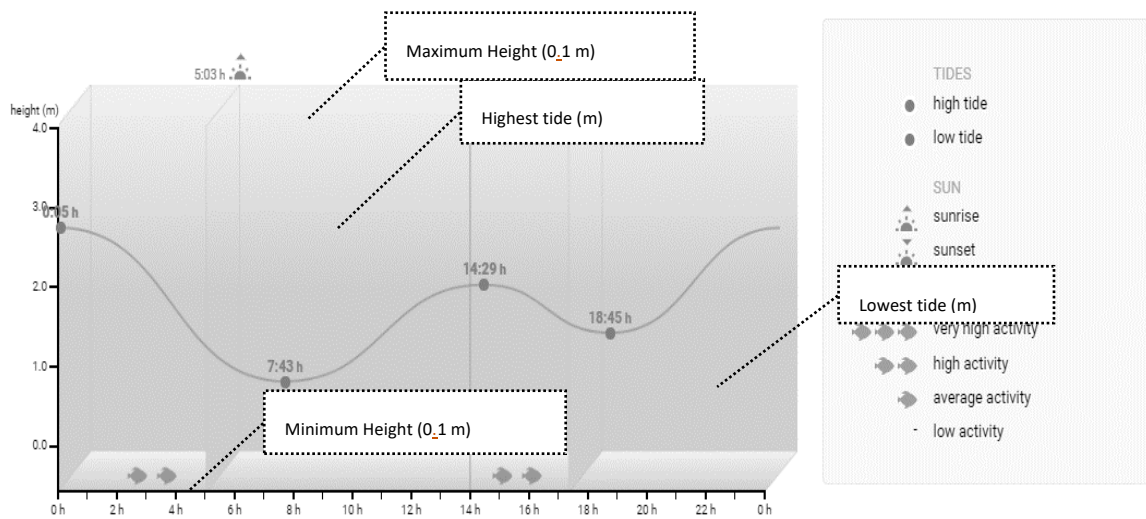

Figure 12. Fluctuating wave high in 2018 (Source: Tides 4 fishing, 2018)

The results of tidal observations became the basic planning of the shrimp pond elevation. In detail for construction, we also using local contour shape to monitor the condition of the pond was under the tides. The local contour shape can be seen in Figure 11. The bathymetry map also provides us the tidal propagate scenario, the detail of the bathymetry around the location can be seen in Figure 12.

We also consider the material properties for dike and pond structure protection. The result of the soil characteristics shows that the material consists of 62,85% silt, 20% sand, and 17,15% Clay. We assume the pond still stable if the wave propagates not too fast into the pond and we have the opportunity that our model behind the natural breakwater.

The distribution of material for structure can be seen in Figure 12. The existing perimeter for the fishpond can be seen in Figure 13.

In the existing design of the pond dike perimeter the freeboard was not too high and the slope ratio already 1:2, we choose more thickness in the bottom pond dike construction which uses a slope ratio of 1:2, we redesign this dike to make the pond dike more stable at high tide. We choose this design because it is the optimum dike ratio between the volume of soil and height to provide strength and safety against seawater tides (Figure 14). To support the system from failure we use the bottom suction drainage system (Figure 15) and to make it clean, stable, also safe we put the pipelines under a dike structure (Figure 16).

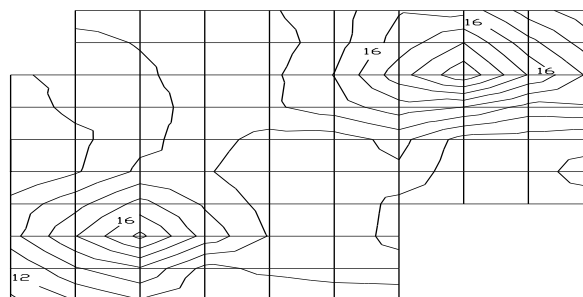

Figure 13. The local contour map using direct measurement

DOI: 10.32663/ja.v%vi%i.2582

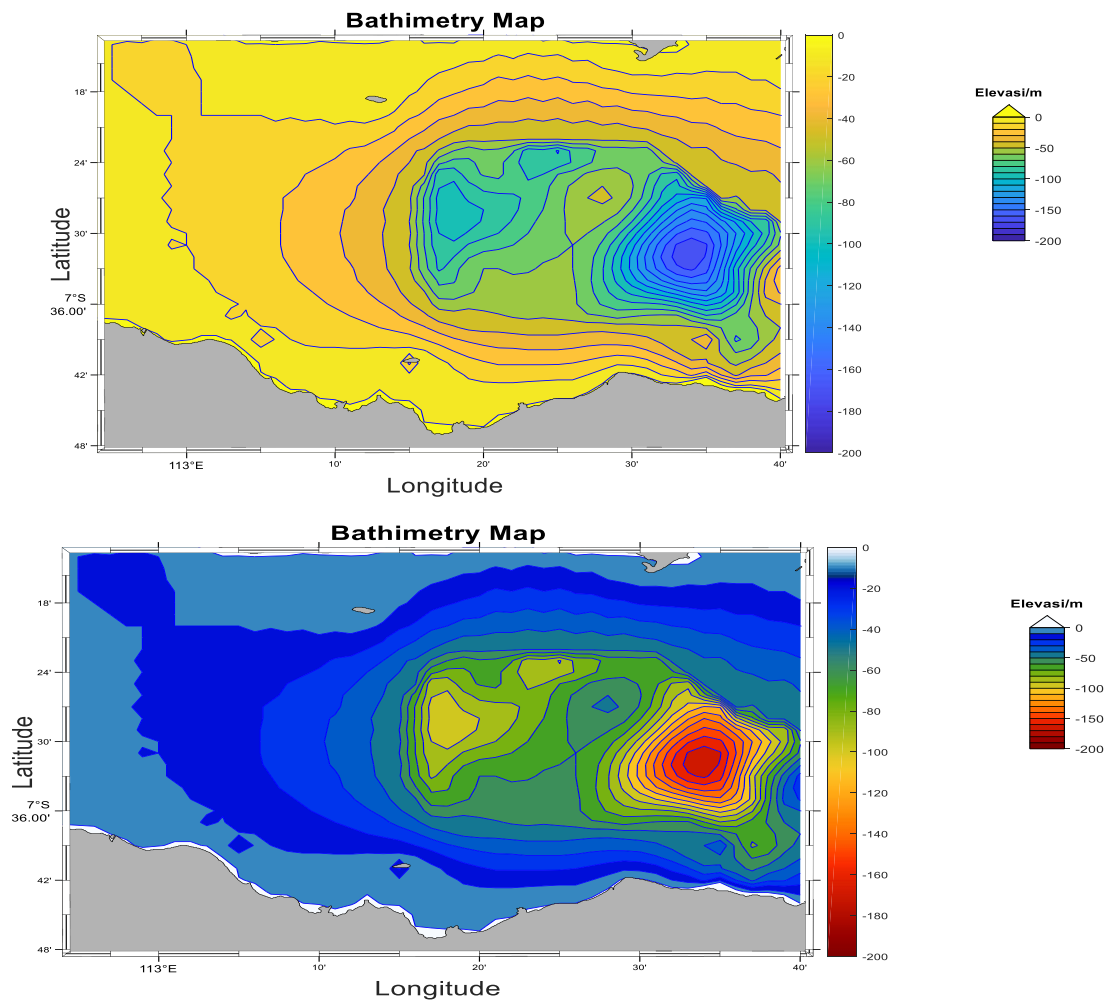

Figure 14. The Bathymetry around the location.

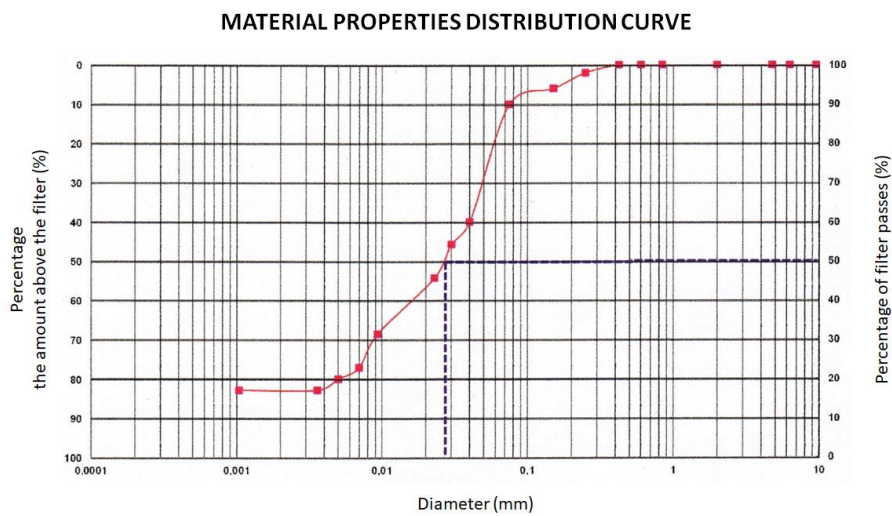

Figure 15. The Soil properties for pond construction.

DOI: 10.32663/ja.v%vi%i.2582

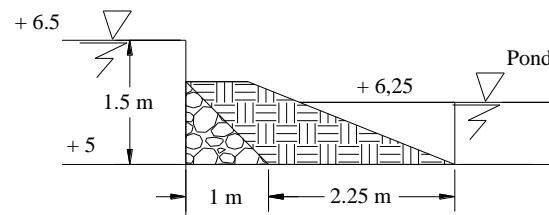

Figure 16. Existing conditions of perimeter embankment. (Source: Fidari et al, 2017).

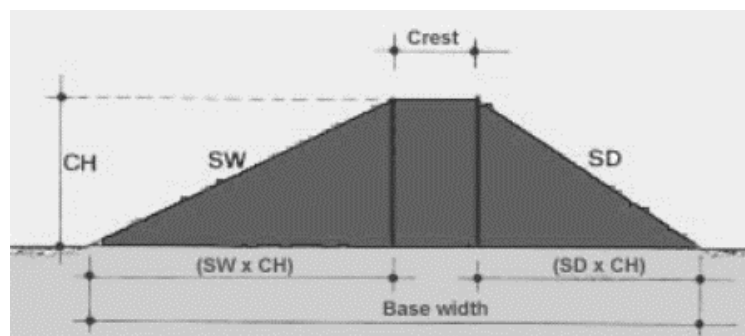

Figure 17. Calculations used for dike design (Source: Kyung and Claude, 1994).

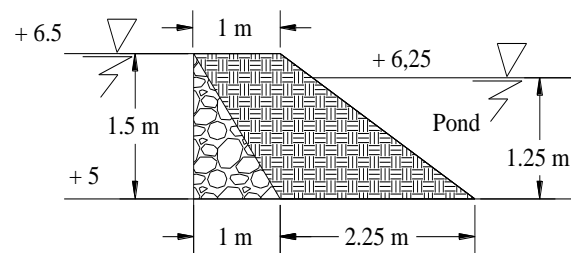

Figure 18. The optimum dike against wave height fluctuation. (Source: Fidari et al, 2017).

An exhaust system was used by utilizing an under-drain system as water disposal of shrimp pond in stage 1. For under-drain, a pond drainage system with water replacement at the bottom layer of the pool has been conceptualized so that the conditions of radiation and flow turbulence could be minimized. The design selection

was intended to make the shrimp more comfortable life in laminar flow with bottom circulation, with that condition (Figures 17 and 18) shrimp can reproduce, change skin, carry out metabolic processes regularly. The other benefit is the pond can be cleaned with efficiently.

DOI: 10.32663/ja.v%vi%i.2582

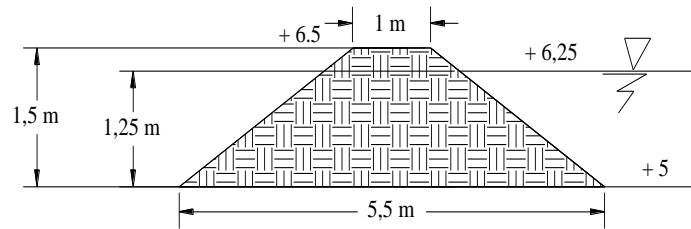

Figure 19. Dike for pond separation (Source: Fidari et al, 2017).

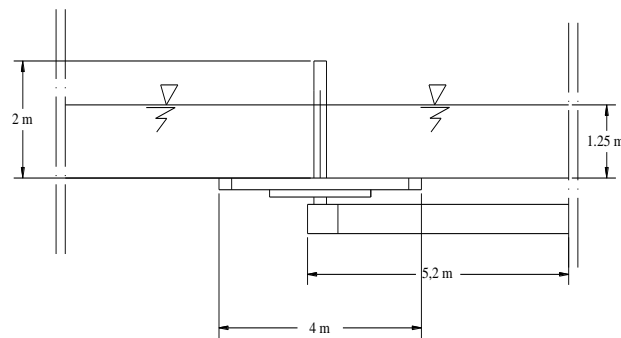

Figure 20. The result of analysis of the optimal shrimp pond embankment perimeter at the research site.

The division of the pond's partition into four sections consisting of an area of $31.5 \text{ m} \times 31.5 \text{ m}$ for each part, so that the total width of the pond area became

5285.29 m^2 . The distribution of the pond's partition is shown in Figure 19, whereas the cross-section layout is shown in Figure 20.

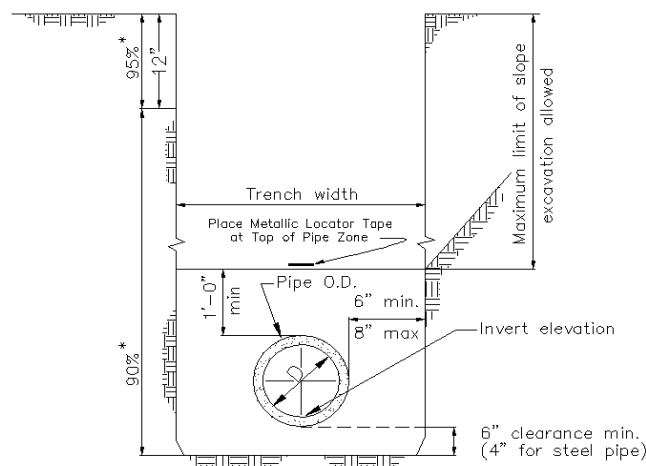

Figure 21. Shrimp pond piping system for disposal.

DOI: 10.32663/ja.v%vi%i.2582

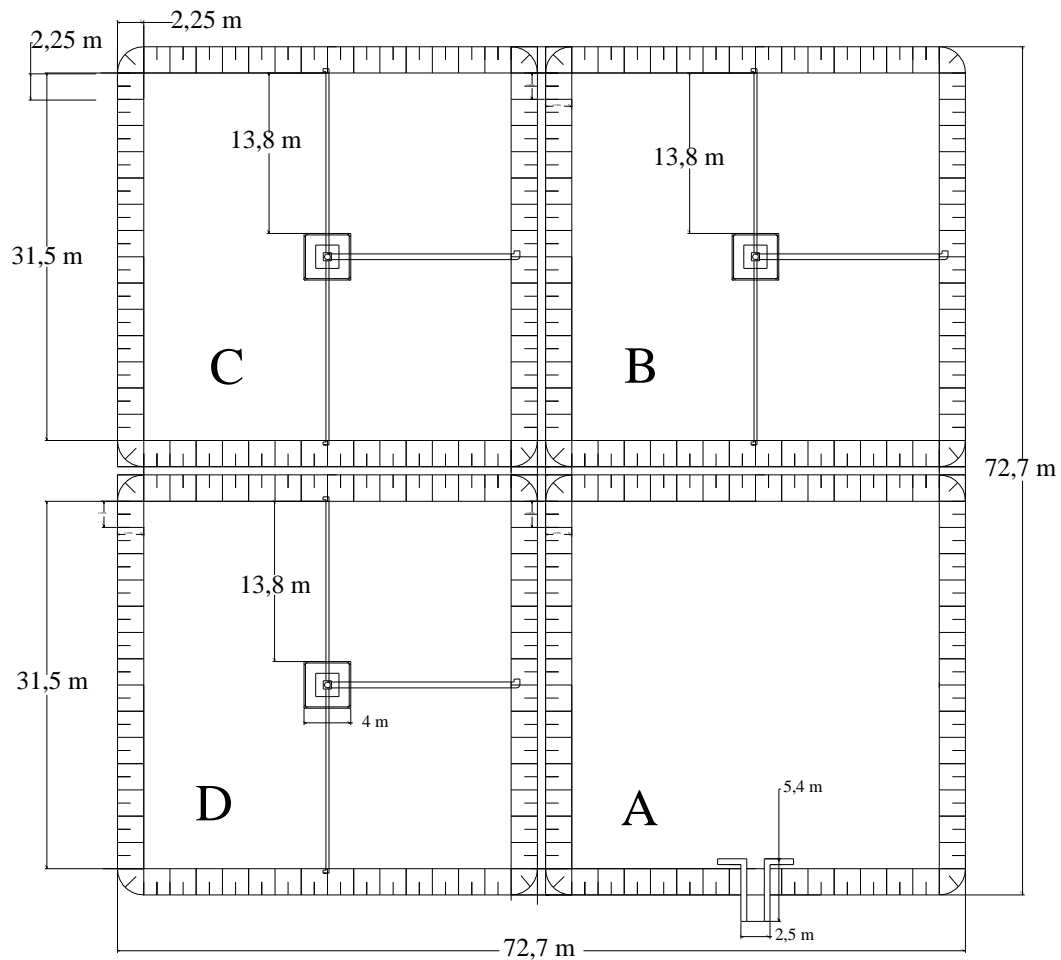

Figure 22. The division of shrimp pond partition. (Source: Fidari et al, 2017).

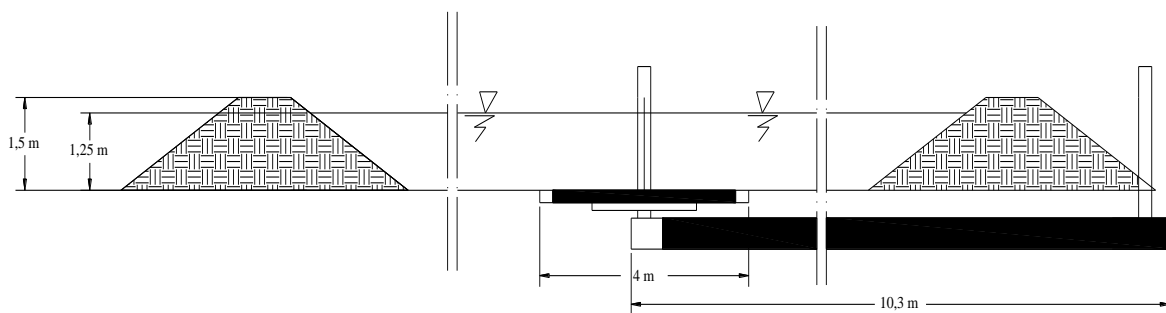

Figure 23. The shrimp pond cross-section. (Source: Fidari et al, 2017).

At the beginning of the planning, there were two alternatives to fill the shrimp pond (Figures 2 and 4). In Alternative 1 (Figure 2), the inlet was an existing channel, and the pond filling was carried out following the normal sea tides, but only the inlets and outlets were arranged. In Alternative 2, (Figure 4) water was directly

taken from the sea via drilling, and then, it was streamed through the pipeline into the shrimp pond. Alternative 1 with an added adjustment on the reinforcement of the outlet channel was chosen so that when the tide was high, it would not mix the inlet and outlet water.

DOI: 10.32663/ja.v%vi%i.2582

Based on the data obtained from the simulated tides that occurred in the Madura Strait from 2010 to 2017 and information from the laboratory at UPT Fisheries Department of Probolinggo, it was concluded that the height of the highest tide ever recorded was 3 m. Thus, planned dike development should protect against 3 m tides.

In the observation field, the tidal range was 3 m, and at the time of the survey, the height of the tide rose to 1.75 m. At a station 2 km away from the coast, the seawater conditions were recorded; the surface water temperature was 32°C, and the temperature at 1 and 5 m depths were similar at 30°C. The salinity value from all points was 30 ppt. The water transparency was 2 m, and the watercolor was green. The water depth at the site was 5 m.

Designing the pond for open shrimp pond irrigation involves tide and wave challenges that due to the presence of tidal interventions that occurred. The possibility that the shrimp commodity will be disrupted is immense. The pond model is planned to be modified for a perimeter embankment (protective embankment) that is as high as 0.5 m. By looking at the occurred trend of tidal data, the additional 0.5 m is considered to be appropriate. For the needs of shrimp pond irrigation, it is necessary to design a suitable pond, that is, a production pond, since almost all shrimp are located in this pond.

Acknowledgments

The author thanks the Coastal and Marine Research Center Brawijaya University for facilitating this research.

Conflict Of Interest

There is no conflict interest in this research.

REFERENCES

- Ashton, Elizabeth, C. (2007). The impact of shrimp farming on mangrove ecosystems. CAB Reviews Perspectives in Agriculture Veterinary Science Nutrition and Natural Resources. Retrieved from https://www.researchgate.net/publication/248908889_The_impact_of_shrimp_farming_on_mangrove_ecosystems
- Claude, E.B. (2003). Bottom soil and water quality management in shrimp ponds. *J. Appl. Aquacult.*, 13(1), 11-33.
- Cruz, C.R.D. (2014). Fishpond engineering: a technical manual for small and medium scale coastal fish farms in South East Asia. [cited 2018 Jan 15]. Retrieved from: <http://www.fao.org/tempref/FI/CDrom/aquaculture/a0845t/volume2/docrep/field/003/e7171e/E7171E01.htm>.
- Feedpedia. (2016). Animal feed resources information system-INRA CIRAD FAO; [cited 2020 Feb 13]. Retrieved from: www.feedpedia.org.
- Fidari, Jadfan, S., Maftuch, Bisri, M. (2017). Intensive Pool Design Model Planning Probolinggo District. 8(2017), 252-261. Retrieved from: <https://www.jurnalpengairan.ub.ac.id/index.php/jtp/article/view/357>.
- Hein, Lars. (2000). Impact of shrimp farming on mangroves along India's East Coast. *Unasyuva*, 203(51), 48-55. Retrieved from: <http://www.fao.org/tempref/docrep/fao/x8080e/x8080e08.pdf>.

DOI: 10.32663/ja.v%vi%i.2582

- Joffrea, Olivier, M., Marijn, P., Klerkxc, L. (2018). Are shrimp farmers actual gamblers? An analysis of risk perception and risk management behaviors among shrimp farmers in the Mekong Delta. *Aquaculture*, 495, 528-537. Retrieved from: <https://www.sciencedirect.com/science/article/pii/S0044848618301108>.
- Kyung, H.Y., Claude, E.B. (1994). *Hydrology and water supply for pond aquaculture*. New York: Springer Science Business Media Dordrecht.
- Ling, C., James, S.D., Gregory, A.K., Qiuming, L. (2013). Life cycle assessment of Chinese shrimp farming systems targeted for export and domestic sales. *Environ. Sci. Technol.*, 45(15), 6531-6538.
- Low, S.J., Othman, H. (2017). Layout and Construction of Freshwater Fishponds In Malaysia. Retrieved from: <http://www.fao.org/docrep/field/003/AC014E/AC014E04.htm>.
- Marianne, H. (2010). The environmental issue of fish farming in offshore water: perspectives, concerns, and research needs. *Aquacult. Environ. Interact.*, 1, 57-70.
- Ogbe, F.G., Takwa, K.T., Adegoye, M.S., Akoh, J.I. (2005). The hydrology of a small fish pond at the University of Agriculture. Benue State, Makurdi Experimental Fish Farm. In: 14th Annual Conference of the Fisheries Society of Nigeria (FISON). Ibadan, Nigeria, 103-107.
- Sen Nag, Oishimaya. (2017). 10 Countries With The Longest Coastlines In Asia. *WorldAtlas*, Dec. 19. Retrieved from: worldatlas.com/articles/10-countries-with-the-longest-coastlines-in-asia.html.
- Shunji, S., Derek, S., Simon, F.S. (2004). *Status and potential of fisheries and aquaculture in Asia and the Pacific*. Bangkok: Food and Agriculture Organization of the United Nations Regional Office for Asia and the Pacific.
- Tides 4 Fishing. (2018). Progression of the tidal coefficient in January of 2018 [cited 2020 Feb 13]. Retrieved from: <https://tides4fishing.com/tides/tidal-coefficient>.
- Varga, Monika, Csukasa, B., Kucskab, B. (2020). Implementation of an easily reconfigurable dynamic simulator for recirculating aquaculture systems. *Aquacultural Engineering*, 90(2020), 102073. Retrieved from: <https://www.sciencedirect.com/science/article/pii/S0144860919302183>
- Viv, D.P., Engki, A.K. (2013). Prediction of sea-level rise impacts on the coastal areas of Surabaya using GIS. *Int. J. Eng. Sci.*, 2(7), 1-9.